

CANOPUS PRO

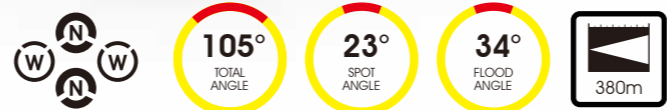
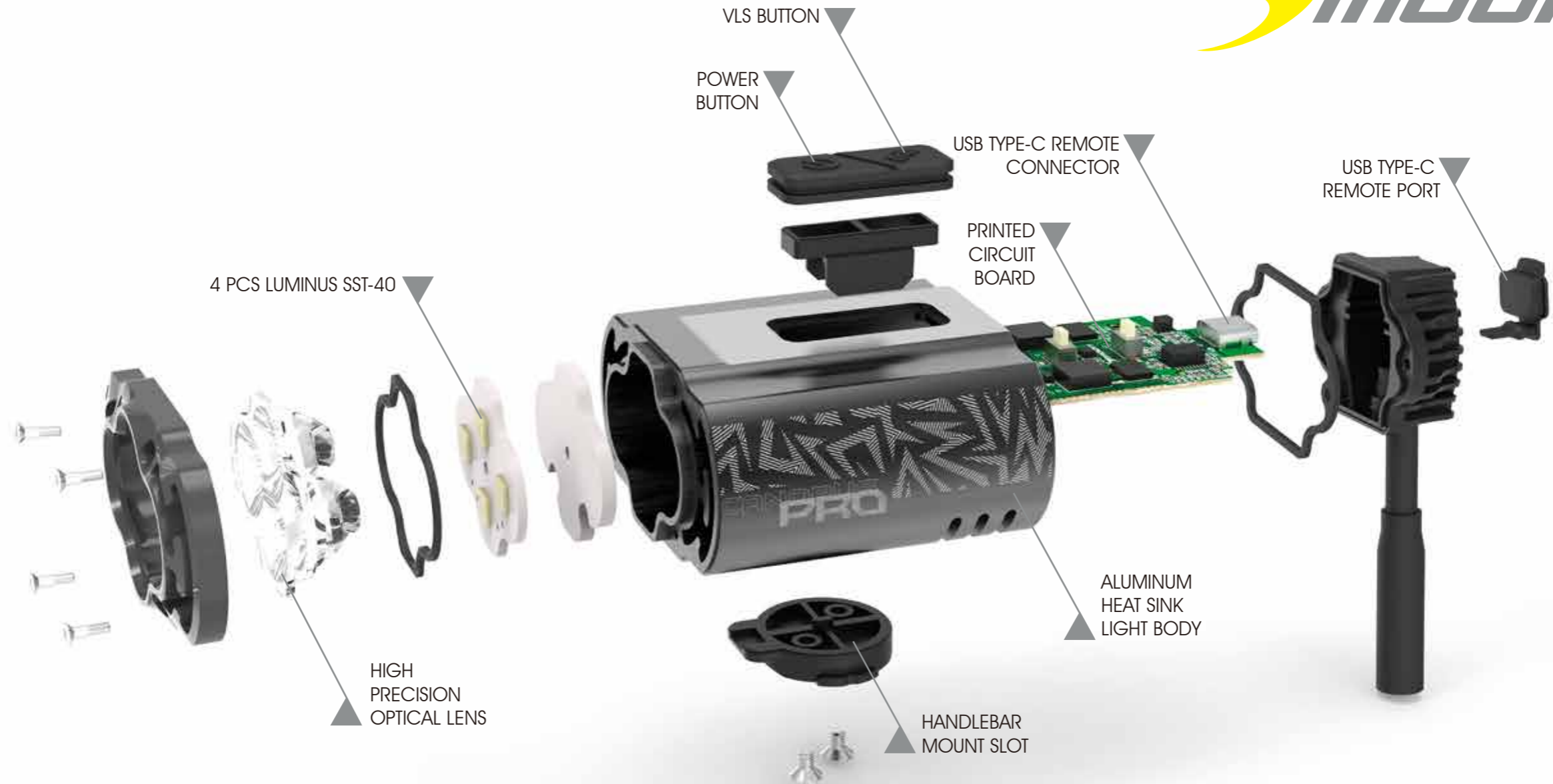

FEATURES

- * Boost mode
- * Dual angle beam
- * Day flash mode
- * Light mode memory
- * CNC Aluminum heat sink casing
- * USB remote control system
- * External battery pack
- * Over heat protection system
- * Quick release handlebar mount
- * Quick release helmet mount
- * Low battery, charging and fully charged indicator
- * Automatic fully charged cut-off system
- * Water resistant (IPX 7)
- * Water resistant USB port
- * Lock mode
- * Variable lumen system
- * FL-1 tested lumen
- * FL-1 tested runtime
- * FL-1 tested beam distance

CONTENTS INCLUDED

- RB-41 (Helmet Mount)
- RB-36 (Handlebar Centre Mount)
- USB-C (USB Type-C cable)
- USB-CTC (USB-C To USB-C Cable)
- USB-C-RM2020 (USB-C Remote Control)
- EXC (Extension Cable)
- XP-BSM-0813 (Velcro Band)
- BS-S6 (External Battery Pack)

OPERATION



ON / OFF : Press 1s

MODE SELECT : Click

STEADY / FLASH : Press and hold 2S

BOOST MODE : Double click

LOCK/UNLOCK : 1. Power off
2. Press 5s:

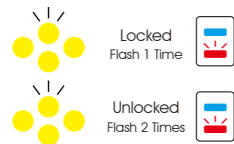

BATTERY INDICATOR :

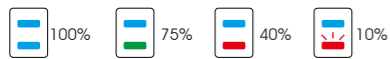

* Lock system:

Lock and prevent the light from turning on accidentally.

* Mode memory:

The light resumes the previous mode upon the next usage.



VLS VARIABLE LUMEN SYSTEM

1. Select the desired mode.
2. Press and hold to set lumen.
3. Release when the desired lumen is reached.

* Light flashes twice when either the MAX or MIN lumen level is reached.

* Restore the default mode:

Press +

* Mode memory:

The light resumes previous VLS setting upon the next usage.

RUNTIME



	BOOST	MODE1	MODE2	MODE3	FLASH1	FLASH2	DAY FLASH	SOS
DEFAULT LUMEN	6000	4000	2000	600	100	300	400	150
LUMEN								
H:MIN	2:00	3:00	6:30	25:00	550:00	155:00	600:00	250:00
VLS LUMEN								
H:MIN	-	4000 100	4000 100	4000 100	4000 100	4000 100	4000 100	-
H:MIN	-	3:00 130:00	3:00 130:00	3:00 130:00	16:00 550:00	24:00 200:00	70:00 1500:00	-

HEAT CONTROL SYSTEM

OVERHEAT PROTECTION

The overheat protection device can ensure the bicycle light in a good running temperature condition, so the LEDs can be protected from burning. If the light is in high temperature during operation, it will dim the light output.

The high brightness LED will heat up the light body while working. The Air Vent Cooling System lets the air flows through the light body and reduce the heat. The good cooling system maintains better LED performance and the overall reliability of the light.



FRONT VIEW

REMOTE CONTROL



USB TYPE-C REMOTE PORT

1. Open the light USB port cover.
 2. Plug in the remote control cable.
- * Unplug the cable and close the port cover when not in use.
* Do not plug in the other USB cable or charger.

BRACKET MOUNTING

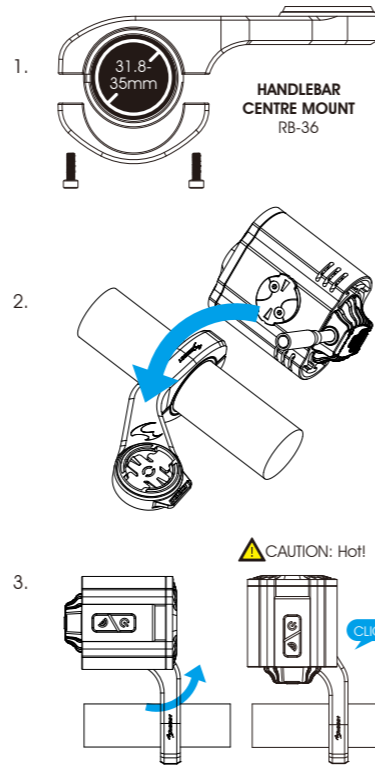

CAUTION: Hot!

CLICK

HELMET MOUNTING

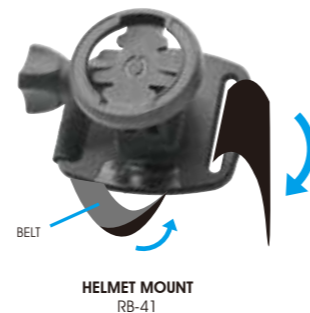

HELMET MOUNT
RB-41

BATTERY CONNECTION

Plug the DC cable into the light.



Battery Indicator (Running)

100%

70%

50%

25%

10%

BS-S6 (PD3.0/ QC3.0/ PPS 18W Max.)
INPUT : (USB-C) 5V/3A; 9V/2A; 12V/1.5A Max.
OUTPUT : (DC PLUG) 7.2V/10A (USB-C) 5V/3A; 9V/2A; 12V/1.5A Max.
RATING : 7.2V 10050mAh 72.36Wh

* Make sure the light is powered off before unplugged the DC cable.

BATTERY CAPACITY

Press to show the battery capacity.



POWER SUPPLY

1. Unplug the DC cable.
 2. Plug the USB-CTC cable into the battery.
 3. Plug the USB-CTC into the device and get charged.
 4. Unplug the cable after charging.
- * Do not charge any device without global safety standard.
* Close the cover when it is not in use.
* keep away from flammable objects while charging.



Power Output Indicator

Battery Level

Charging

Quick Charge Power Output Indicator

Battery Level

Charging

EXTENSION DC CABLE

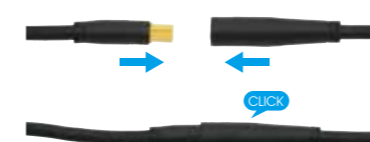

BATTERY CHARGING

1. Power off.
2. Plug the USB cable into the USB port.
3. Unplug the USB cable after fully charged.

* Close the cover when it is not in use
* keep away from flammable objects.



Charging Indicator (Input)

10%

25%

50%

70%

100%

Quick Charge Indicator (Input)

10%

25%

50%

70%

100%

No Power Input Detected

BATTERY MOUNTING



WARNING

- * Understand your country lighting laws and regulations before using the light.
- * Do not shine light directly into eyes.
- * Do not mount the light near wireless computer.
- * Do not glare the oncoming vehicles. Always adjust the angle downward.
- * Do not submerge the light into water.
- * Keep the light in a cool and dry place when storing.
- * Fully recharge the light at least every 3 months during storage.
- * After 300 times of charge/discharge, the battery capacity may become less effective and may stay at the capacity percentage of 80%.
- * Do not dismantle the battery case.
- * Do not charge except the battery capacity condition is required.
- * Keep battery away from fire and combustible materials.
- * The temperature in 60°C may result in short circuit.

WARRANTY

MOON Lights are covered by a **2-year LIMITED WARRANTY**, while MOON batteries are covered by a **180-day warranty**, both starting from the date of purchase.

This warranty covers defects or malfunctions arising from manufacturing or design flaws in the product. It does not cover normal wear and tear, non-rechargeable batteries, and damage caused by improper installation, misuse, mishandling, accidental loss, abuse, accidents, or negligence.

MOON may require the return of any product submitted for warranty consideration. Customers should contact their authorized local dealer or authorized regional distributor for warranty service.

For more information, please contact cs@moon-sport.com.
ONLINE WARRANTY REGISTRATION
Please visit www.moon-sport.com for online warranty registration.