

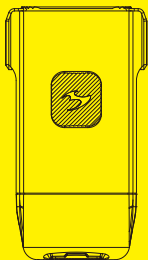

# RIGEL LITE MANUAL



Read this manual carefully before using and keep for future reference.  
Visit [www.moon-sport.com](http://www.moon-sport.com) for manual updates. The specifications and design are subject to change without notice.

## CONTENTS

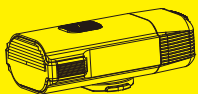

RIGEL LITE



RB-43  
(HANDLEBAR BRACKET)



RB-42  
(MOON LIGHT ADAPTER  
FOR GOPRO MOUNT)

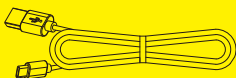

USB-C  
(USB CABLE)

### Optional accessories:

- USB-C-RM2020 (REMOTE CONTROL)
- RB-36 (HANDLEBAR CENTRE MOUNT)
- RB-41 (HELMET MOUNT)
- M-01 (HANDLEBAR COMBO MOUNT XL)
- M-03 (STEM CAP MOUNT)
- M-06 (AMPLITUDE RACE MOUNT)
- M-07 (HANDLEBAR MOUNT)

## OPERATION

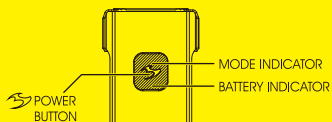

- ON / OFF : Press & hold
- MODE SELECT : Click
- STEADY / FLASH : Double Click
- BATTERY CHECK : 1. Power off

2. Click

- 100%
- 50%
- 25%
- ≤ 10%
- > 10%

\* Mode memory: Resumes previous mode on next use.

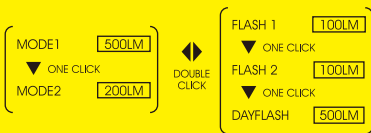

## RUNTIME

	DEFAULT			
ANSI FL1	LUMEN	H:MIN	VLS LUMEN	H:MIN
MODE 1	500	1:45	500 50	1:45 16:00
MODE 2	200	4:30	500 25	1:45 16:00
FLASH 1	100	40:00	500 25	9:00 65:00
FLASH 2	100	20:00	500 25	6:00 36:00
DAYFLASH	500	40:00	500 50	40:00 160:00

DEFAULT / NORMAL  
DEPENDS ON MODE LUMENS

## VARIABLE LUMEN SYSTEM



- Select desired mode.
- Press and hold to adjust lumen.
- Release at desired lumen.

\* Light flashes twice at MAX or MIN lumen.

\* Restore default mode:

- Power off
- Press 7s: BLUE FLASH 3 TIMES



## ROTATABLE ANTI-DAZZLING LENS

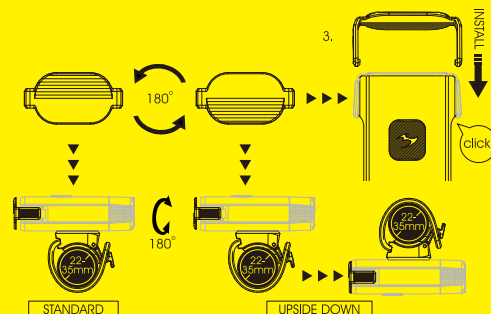
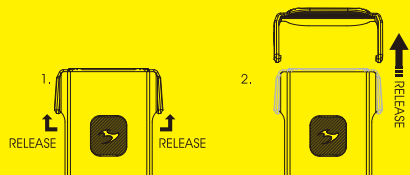

## HANDLEBAR MOUNTING

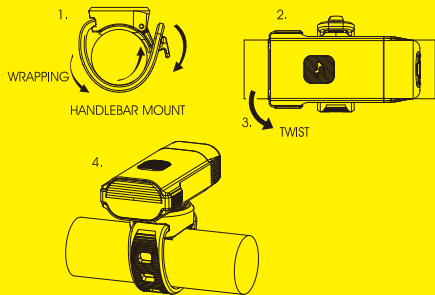

## GOPRO MOUNT

MOON LIGHT ADAPTER  
FOR GOPRO MOUNT  
LENS INSTALLATION

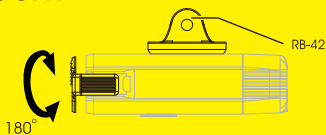

UPSIDE DOWN

## CHARGING

1. Power off.
2. Plug USB cable to USB port.
3. Unplug after fully charged.



- \* Do not charge over 5V.
- \* Keep away from flammable objects while charging.

## BATTERY LEVEL AND CHARGING INDICATOR

	100%	50%	25%	≤ 10%
Battery level	BLUE	GREEN	RED	RED (Slow Flash)
Charging (Double Flash)	BLUE		Fully charged * 2:30hrs	BLUE

## OVERHEAT PROTECTION

The overheat protection device can ensure the bicycle light in a good running temperature condition, so that to protect the LEDs without burning case. If the light is in high temperature during operation, it will dim the light output.

## WARNING

Before use, check local lighting laws and regulations.  
Avoid shining the light directly into anyone's eyes.  
Do not install near wireless cycling computers.  
Prevent blinding oncoming traffic — always angle the beam downward.  
Keep the light away from water; do not submerge it.  
Store in a cool, dry place.  
If stored long-term, recharge the light fully at least every 3 months.

## WARRANTY

MOON Lights come with a **2-YEAR LIMITED WARRANTY**, and MOON batteries are covered for **180 days**, with both warranties effective from the date of purchase. This warranty covers any defects or malfunctions resulting from manufacturing or design issues.

The warranty does not apply to normal wear and tear, damage from using non-rechargeable batteries, or any problems caused by improper installation, misuse, accidents, negligence, or other mishandling. To request warranty service, customers should contact their authorized local MOON dealer, as we may need the product returned for evaluation.

For additional assistance, please email our customer service team at [cs@moon-sport.com](mailto:cs@moon-sport.com). Don't forget to register your warranty online at [www.moon-sport.com](http://www.moon-sport.com) to ensure full coverage.



# RIGEL LITE MANUAL

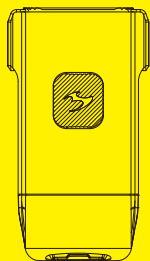

Leia este manual atentamente antes de usar e guarde para referência futura. Visite [www.moon-sport.com](http://www.moon-sport.com) para atualizações do manual. As especificações e o design estão sujeitos a alterações sem aviso prévio.

## CONTEÚDO

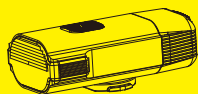

RIGEL LITE



RB-43  
(SUPORTE PARA GUIADOR)



RB-42  
(ADAPTADOR LUZ MOON  
PARA SUPORTE GOPRO)

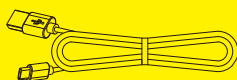

USB-C  
(CABO USB)

### Accessórios opcionais:

- USB-C-RM2020 (COMANDO)
- RB-36 (SUPORTE PARA CENTRO DO GUIADOR)
- RB-41 (SUPORTE PARA CAPACETE)
- M-01 (SUPORTE COMBO XL PARA GUIADOR)
- M-03 (SUPORTE PARA TAMPA DE AVANÇO)
- M-06 (SUPORTE AMPLITUDE RACE)
- M-07 (SUPORTE PARA GUIADOR)

## FUNCIONAMENTO

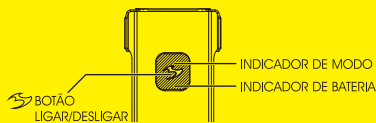

LIGAR/DESLIGAR : Pressionar

SELEÇÃO MODO : Clicar

FIXO / FLASH : Duplo clique

VERIFICAÇÃO DA BATERIA : 1. Desligar

2. Clicar

100% 50% 25% ≤10%

AZUL VERDE VERMELHO VERMELHO

\* Modo memória: Retorna o modo anterior na próxima utilização.

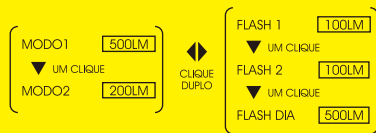

## DURAÇÃO DA BATERIA

		PADRÃO			
ANSI FL1	LUMEN	H:MIN	VLS LUMEN	H:MIN	
MODO 1	500	1:45	500 50	1:45 16:00	
MODO 2	200	4:30	500 25	1:45 16:00	
FLASH 1	100	40:00	500 25	9:00 65:00	
FLASH 2	100	20:00	500 25	8:00 36:00	
FLASH DIA	500	40:00	500 25	40:00 150:00	
PADRÃO / NORMAL DEPENDE DO MODO DE LUMENS					

## SISTEMA DE LUMENS VARIÁVEIS (VLS - VARIABLE LUMEN SYSTEM)



1. Selecionar o modo desejado.
2. Manter pressionado para ajustar os lumens.
3. Soltar quando atingir o nível de lumens desejado.

\* Luz pisca duas vezes ao atingir o nível máximo e mínimo de lumens.

\* Restaurar modo padrão:

1. Desligar

2. Pressionar 7s: AZUL VERMELHO PISCA 3 VEZES



## LENTE ROTATIVA ANTI-ENCANDEAMENTO

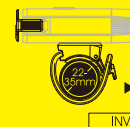
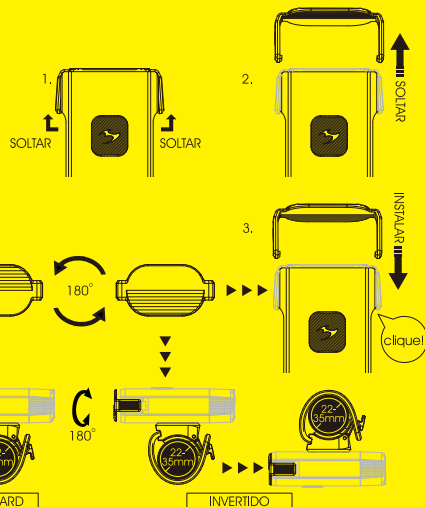

## INSTALAÇÃO SUPORTE PARA GUIADOR

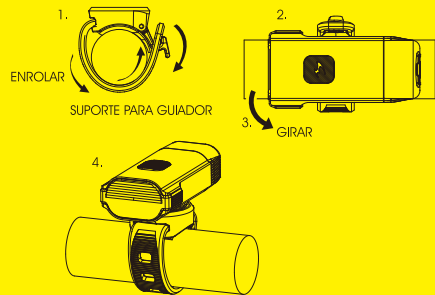

## INSTALAÇÃO SUPORTE PARA GÓPRO

ADAPTADOR LUZ MOON PARA SUPORTE GOPRO  
INSTALAÇÃO DA LENTE

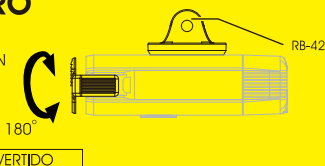

## CARREGAMENTO



1. Desligar.
2. Conectar cabo USB à porta USB.
3. Desconectar após estar totalmente carregado.

\* Não carregar acima de 5V.

\* Mantenha afastado de objetos inflamáveis durante o carregamento.

## NÍVEL DA BATERIA E INDICADOR DE CARREGAMENTO

	100%	50%	25%	≤10%
Nível da bateria	AZUL	VERDE	VERMELHO	VERMELHO (Pisca lentamente)
Carregamento (Duplo Flash)	AZUL	Carregamento completo * 2:30h AZUL		

## PROTEÇÃO CONTRA SOBREAQUECIMENTO

A funcionalidade de proteção contra sobreaquecimento mantém a luz da bicicleta a uma temperatura segura, evitando que os LEDs se queiem. Se a luz aquecer demasiado durante a utilização, reduzirá automaticamente a intensidade para diminuir a temperatura.

## AVISO

Antes de utilizar, verifique as leis e regulamentações locais de iluminação.

Evite apontar a luz diretamente para os olhos.

Não instale próximo de ciclocomputador sem fios.

Evite encandear o trânsito em sentido contrário, incline o feixe de luz sempre para baixo.

Mantenha o dispositivo afastado da água, não o submerja.

Guarde num local fresco e seco.

Se armazenado por um longo período, recarregue a luz completamente pelo menos a cada 3 meses.

## GARANTIA

As luzes MOON têm uma **GARANTIA LIMITADA DE 2 ANOS**, e as baterias MOON têm uma garantia de **180 dias**, válidas a partir da data de compra. Esta garantia cobre quaisquer defeitos ou falhas resultantes de problemas de fabrico ou design.

A garantia não se aplica ao desgaste normal, danos causados pelo uso de baterias não recarregáveis, ou quaisquer problemas resultantes da instalação incorreta, utilização indevida, acidentes, negligência ou qualquer manuseamento incorreto. Para solicitar assistência ao abrigo da garantia, os clientes devem contactar o revendedor local autorizado MOON, podendo ser necessária a devolução do produto para avaliação.

Para assistência adicional, por favor envie e-mail para o serviço de apoio ao cliente [cs@moon-sport.com](mailto:cs@moon-sport.com). Não se esqueça de registar a sua garantia online em [www.moon-sport.com](http://www.moon-sport.com) para garantir a cobertura completa.